

# Water Products

Viscount Rotational Mouldings over the years have developed an extensive range of pits suitable for the housing of control valve and meters. From the two legged round pit, water hydrant pit, rural water air valve pit, to the combined collared hydrant pit, Viscount offer the highest quality in underground products. The strong reinforced dual skin lids are available in both the standard and snap lock varieties including embossed names such as Hydrant, Air Valve, Valve and Sewer. The lids are also available in a wide range of colours that can assist in identifying the purpose of the equipment housed. The UV Stabilised polyethylene flushing meter box comes with a security lid.



WA1501 - Hydrant Pit

WA1520 - Collared Hydrant Pit

WA1504 - Rural Valve Pit

WA1500 - 2 Leg Pit

Code	Product	B	B1	B2	C	C1
WA1501	Hydrant Pit	430	395	-	425	-
WA1520	Collared Hydrant Pit	610	395	370	420	93
WA1504	Rural Valve Pit	430	395	375	735	85
WA1500	2 Leg Pit	435	395	315	620	90

All measurements in millimetres



UG2033 - G3 Pit

UG2005 - P5 Pit

WA1506 - Flushing Box

Code	Product	A	A1	A2	A3	B	B1	B2	B3	C	C1	C2
UG2033	G3 Pit	700	652	591	570	550	502	441	420	700	648	290
UG2005	P5 Pit	710	650	-	-	455	400	330	-	635	581	230
WA1506	Flushing Box	585	545	455	435	375	340	235	320	350	305	-

All measurements in millimetres

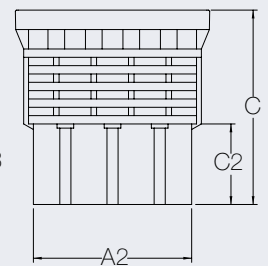
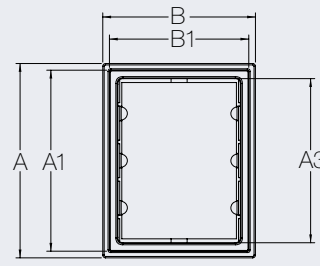
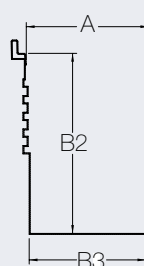
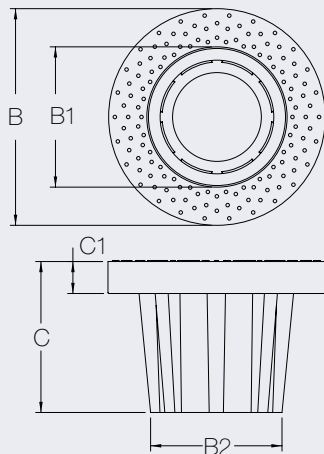

# Water Products



The rotationally moulded lid offers an anti-slip surface embossed with the word 'Water' or 'Sewer' and is secured with the use of a single corrosion resistant, bolt. Viscount's G3 pit along with being in our Gas Product range, has now successfully been used in Grey Water Systems for larger hydrant installations. This highlights the flexibility of product application that applies to all infrastructure products and our ability to adapt to future demands.

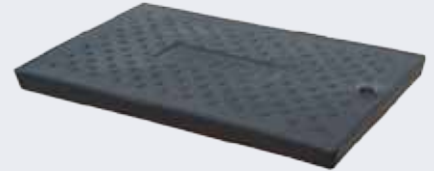
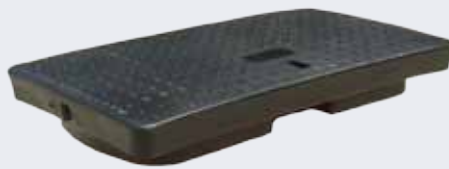
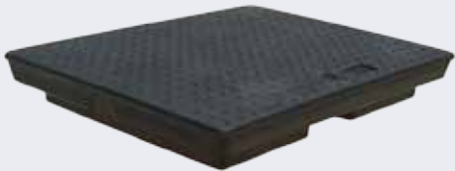

UG2350 - G3 Lockable Lid

UG2300 - P5 Lockable Lid

WA1519 - Flushing Box Lid

Code	Product	A	B	C	C1
UG2300	P5 Lockable Lid	650	397	90	50
UG2350	G3 Lid	650	495	115	50
WA1519	Flushing Box Lid	545	339	38	-

All measurements in millimetres

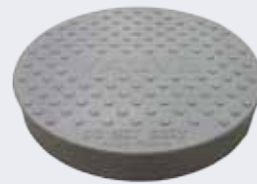

WA1522 Snap Lock Lid Embossed 'Valve'

WA1510 Lid Embossed 'Valve'

- WA1522 'Valve' Snap Lock Lid
- WA1521 'Hydrant' Snap Lock Lid
- UG2026 'Danger Electricity' Snap Lock Lid
- UG2036 'Telecommunications' Snap Lock Lid
- WA1502 'Hydrant Lid
- WA1503. 'Sewer' Lid
- WA1505 'Air Valve' Lid
- WA1510 'Valve' Lid
- WA1525 'Sewer' Snap Lock Lid

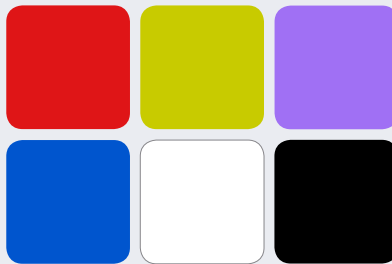

The VRM lids come in a range of colours and embossed names. Custom made plates can be produced to suit both corporate and special applications.



Code	Product	A	A1	C	C1
See above	Lid	390	308	85	62

All measurements in millimetres

